

# Starry Eve

Quilt designed by Denise Russell.



Quilt size: 59-1/2" x 59-1/2".











Featuring  
*Poinsettias & Pine Metallic* by *moda*



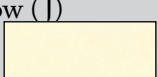

## Fabric Requirements and Cutting Instructions

*Requirements are based on 42" fabric width.*

*Fabrics are cut on the width of fabric (WOF). When cut on the length of fabric, the notation LOF will be indicated.*

Fabric	Yardage	Cutting
33514-14M Holly Berries – Ebony (A) 	1/8 yard	* (9) Leaves with template S. * (9) Leaves with template T.
33515-18M Holly Leaves – Gold (B) 	1/8 yard	* (1) Flower with template E. * (2) Circles with template F. * (2) Circles with template G. * (1) Circle with template H. * (1 each) Petal with template N, Petal with template M, Petal with template L, and Petal with template O.
33515-12M Holly Leaves – Crimson (C) 	1/8 yard	* (2) Flowers with template B. * (1) Flower with template D. * (1 each) Circle with template I and template J. * (1 each) Petal with template P, R, M and L.
33515-17M Holly Leaves – Frost (D) 	1/8 yard	* (1) Flower with template C. * (1) Circle with template H. * (1) Circle with template F. * (1) Petal with template Q. * (12) Circles with template J.
33514-11M Holly Berries – Cream (E) 	1/4 yard	* (1) 6-1/4" x WOF strip. Sub-cut (4) 6-1/4" squares.
33513-15M Poinsettias – Frost (F) 	1/4 yard	* (1) 4-7/8" x WOF strip. Sub-cut (6) 4-7/8" squares; cut once diagonally (12 triangles F1).
33514-12M Holly Berries – Crimson (G) 	1/4 yard	* (1) 4-7/8" x WOF strip. Sub-cut (6) 4-7/8" squares; cut once diagonally (12 triangles G1).
33510-14M Poinsettias & Pine – Ebony (H) 	1/4 yard	* (1) 4-7/8" x WOF strip. Sub-cut (6) 4-7/8" squares; cut once diagonally (12 triangles H1).
33511-12M Poinsettias & Holly – Crimson (I) 	1/4 yard	* (1) 4-7/8" x WOF strip. Sub-cut (6) 4-7/8" squares; cut once diagonally (12 triangles I-1).
9900 11S Bella Solids – Snow (J) 	5/8 yard	* (1) 15-1/2" x WOF strip. Sub-cut: - (1) 15-1/2" square; and - (16) 3-3/8" squares.
33515-13M Holly Leaves – Evergreen (K) 	3/4 yard	* (1) 2" x WOF strip. Sub-cut (16) 2" squares. * (7) 2-1/2" x WOF strips for binding. * (1) Vase with template A. * (2) Flower receptacles with template K. * (1 each) Stem with templates U, U-1, V, V-1, W, X, X-1, X-2, Z, Z-1, and Z-2.

33515-11M Holly Leaves – Cream (L) 	1-1/3 yards	*(2) 3” x WOF strips. Sub-cut (2) 3” x 15-1/2” strips and (2) 3” x 20-1/2” strips. *(1) 5” x WOF strip. Sub-cut (16) 2” x 5” strips. *(2) 6-1/2” x WOF strips. Sub-cut: - (16) 1-7/8” x 6-1/2” strips; and - (16) 2” x 6-1/2” strips. *(1) 8” x WOF strip. Sub-cut (16) 1-7/8” x 8” strips. *(6) 2” x WOF strips for border 1. *(3) Circles with template H.
33510-13M Poinsettias & Pine – Evergreen (M) 	1-5/8 yards	*(1) 5-1/4” x WOF strip. Sub-cut (8) 5-1/4” squares; cut twice diagonally (32 triangles M1). *(1) 15-1/8” x WOF strip. Sub-cut: - (2) 15-1/8” squares - cut once diagonally (4 corner triangles); and - (6) 5” squares. *(1) 29-5/8” x WOF strip. Sub-cut: - (1) 29-5/8” square – cut twice diagonally (4 setting triangles); and - (10) 5” squares (for a total of 16).
Backing fabric: 4 yards.    Batting: 68” x 68”.    Fusible web.		

### Assemble Blocks

#### Notes:

- a. Measurements include 1/4” seam allowances. Sew with right sides together unless otherwise stated. If no direction is specified, press seams toward the darker fabric.
- b. Group fabric pieces by block to facilitate construction. Refer to the cutting instructions and Table 1 below for a list of fabrics used in each block.





 <p style="text-align: center;">Block 1 Fabrics: E, K, <b>F</b>, L, and J.</p>	 <p style="text-align: center;">Block 2 Fabrics: E, K, <b>I</b>, L, and J.</p>
 <p style="text-align: center;">Block 3 Fabrics: E, K, <b>G</b>, L, and J.</p>	 <p style="text-align: center;">Block 4 Fabrics: E, K, <b>H</b>, L, and J.</p>

Table 1. Fabric placement for each block.

1. Draw a diagonal line on the wrong side of the 2" Fabric K squares. With right sides together, place one marked Fabric K square on a corner of one 6-1/4" Fabric E square and stitch on the drawn line. Repeat with the opposite corner of the same square. Trim seam allowances to 1/4" and press open. Repeat with the other corners of the square (*figure 1*). Make four 6-1/4" patches (save three for blocks 2, 3, and 4).

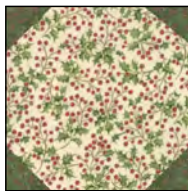

Figure 1 – Make (4) 6-1/4" patches.

2. Fold one Step 1 patch in half with right sides together (the remaining Step 1 patches will be used on blocks 2, 3, and 4). Mark the center on opposite sides of the square. Fold two triangles F1 with wrong sides together and crease to mark the center. Nesting the centers, sew the triangles to opposite sides of the patch. Press the seams open. In the same manner, sew two more triangles F1 to the other sides of the same patch (*figure 2*). Press open and trim ears. The unit measures 8-1/2".

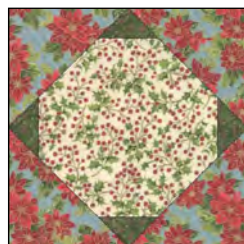

Figure 2 – Make (1) 8-1/2" unit.

3. Sew a 2" x 5" Fabric L strip to one side of a 5" Fabric M square. Press the seam toward the strip. Repeat to make sixteen units. Separate the units into two groups: one with the Fabric L strip to the right and one with the strip to the left of the Fabric M square. Sew a 2" x 6-1/2" strip to the bottom of each unit, making eight 6-1/2" corner units of each type (*figure 3*). Press the seams toward the strip again. Save six of each type for later.



Unit X



Unit Y

Figure 3 – Make (8) 6-1/2" units of each type.

4. Fold a 3-3/8" Fabric J square in half with right sides together. Mark the center on adjacent sides of the square. Fold two triangles M1 with wrong sides together and crease to mark the center. Nesting the centers, sew one triangle to one side, press it open, then sew the second triangle to the adjacent side of the Fabric J square (*figure 4*). Press the seams open and trim ears. Repeat to make sixteen units (the other 12 will be used on blocks 2, 3, 4).



Figure 4 – Make (16) units.

5. Sew the 1-7/8" x 6-1/2" Fabric L strip to the right side of the Step 4 units. Trim the strip as shown on the next page and press open. Sew the 1-7/8" x 8" Fabric L strip to the left side of the same units and trim the strip before pressing it open (*figure 5, next page*).

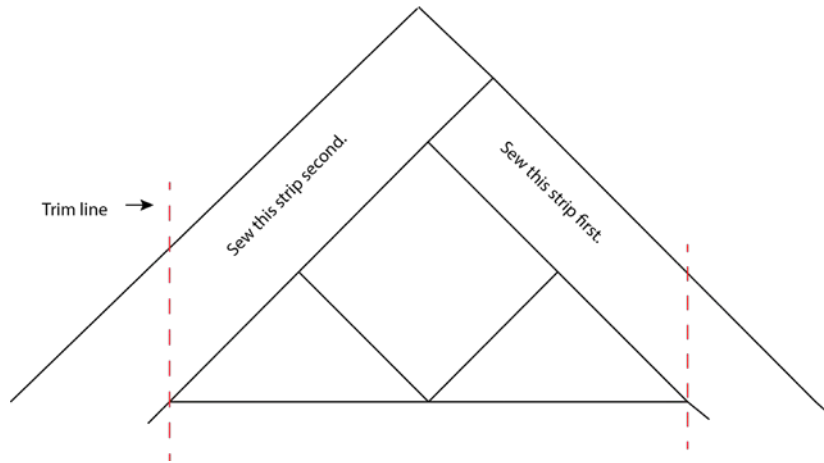

Figure 5

6. Fold the sides of four Step 5 units in half with right sides together. Mark the center on each side. Fold two triangles F1 with wrong sides together and crease to mark the center. Nesting the centers, sew one triangle to one side, press it open, then sew the second triangle to the adjacent side of the units (*figure 6*). Press the seams open and trim ears. Make four 6-1/2" x 8-1/2" units.



Figure 6 – Make (4) 6-1/2" x 8-1/2" units.

7. Sew two Step 6 units to opposite sides of the Step 2 unit (*figure 7*). Press the seams open. The strip measures 8-1/2" x 20-1/2".

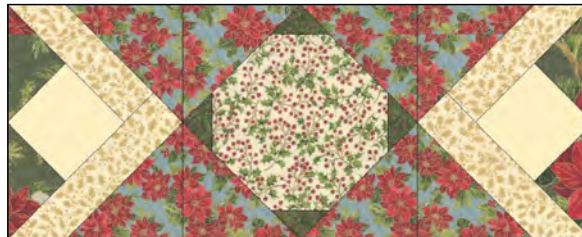

Figure 7 – Make (1) 8-1/2" x 20-1/2" strip.

8. Sew one Step 3 unit X to the left and a Step 3 unit Y to the right of the remaining Step 6 units (*figure 8*). Press the seams toward the corners. Make two 6-1/2" x 20-1/2" strips.



Figure 8 – Make 6-1/2" x 20-1/2" (2) strips.



9. Noting fabric orientation, sew one Step 8 strip to the top and one to the bottom of the Step 7 strip to complete the 20-1/2" block 1 (*figure 9*). Press the seams open.



Figure 9 – Make (1) 20-1/2" block 1.

10. Repeat Steps 2, 6-9 to make blocks 2, 3, and 4 referring to Table 1 for fabric placement.

11. Place the appliqué shapes onto a lightbox or windowpane. Layer the fusible web onto them and trace as many times as indicated on Table 2 below. Cut each shape 1/8" outside the outline and fuse to the wrong side of the fabrics according to Table 2. Cut on the outline and remove paper backing.

Fabric for appliqué shapes	(Quantity) Templates	Fabric for appliqué shapes	(Quantity) Templates
Fabric A	* (9) S * (9) T	Fabric D	* (1) C * (1) H * (1) F * (1) Q * (12) J
Fabric B	* (1) E * (2) F * (2) G * (1) H * (1 each) N, M, L, and O.	Fabric K	* (1) A * (2) K * (1 each) U, U-1, V, V-1, W, X, X-1, X-2, Z, Z-1, and Z-2.
Fabric C	* (2) B * (1) D * (1 each) I and J. * (1 each) P, R, M, L.	Fabric L	* (3) H

Table 2. Fabric for each appliqué shape and cutting instructions.

12. Fold and crease the 15-1/2" Fabric J square in half diagonally twice. Position the appliqué shapes on the square using the creased folds as guidelines and fuse them according to the manufacturer's instructions (*figure 10, next page*). Machine appliqué using matching thread and the blanket stitch.

*moda*

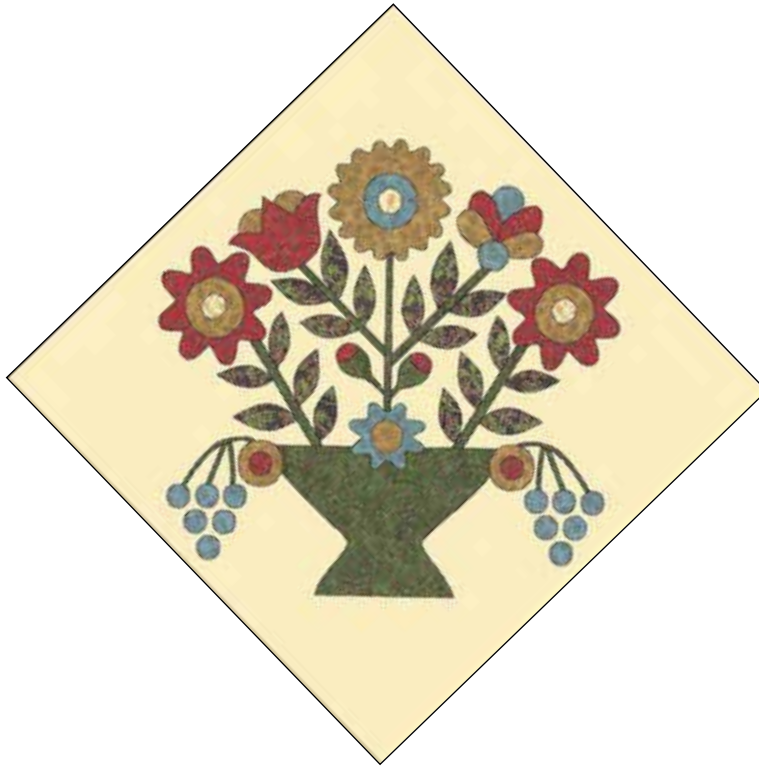

Figure 10

13. Sew two 3" x 15-1/2" Fabric L strips to opposite sides of the Step 12 block and press the seams toward the strips. Sew one 3" x 20-1/2" Fabric L strip to the top and one to the bottom of the block (*figure 11*). Press the seams toward the strips again. The block measures 20-1/2".



Figure 11 – Block measures 20-1/2".

*moda*

## Assemble Quilt Top

14. Following the photograph and quilt assembly diagram for placement and orientation, lay out three diagonal rows of blocks. Add the Fabric M setting triangles to the beginning and the end of the rows. Sew the setting triangles and blocks together in each row, then matching adjacent seams sew the rows together in order.

15. For border 1, join the six 2" Fabric L border strips together end to end using diagonal seams. Measure the vertical length of the quilt top through the center and cut two border strips that length. Sew one strip to each side of the quilt top. Measure the width of the quilt top through the center. Cut two border strips that length and sew one to the top and one to the bottom. Press the seams toward the borders.

## Finishing

16. Create a quilt sandwich with the batting between the quilt top and the backing. Pin or baste layers together, mark quilting design, and quilt by hand or machine. When quilting is complete, remove pins or basting and trim batting and backing even with raw edges of the quilt top.

17. Join the seven 2-1/2" Fabric K binding strips together end to end using a diagonal seam to make one long strip. Fold in half lengthwise and press. Sew binding to the edges of the quilt, mitering corners, and overlapping ends. Fold binding to the back of the quilt and stitch it in place by hand to finish.

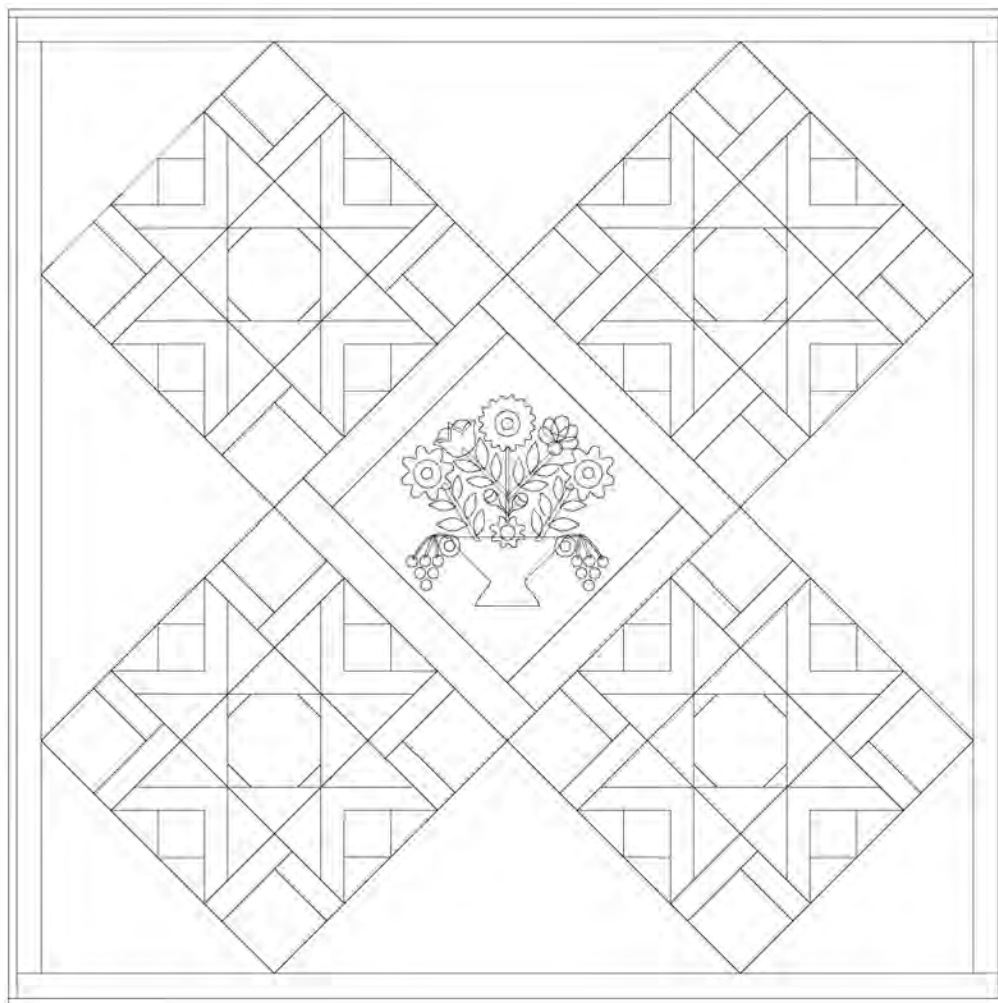

Quilt Diagram



# *Poinsettias & Pine Metallic* Templates

Templates are 100% & Reversed

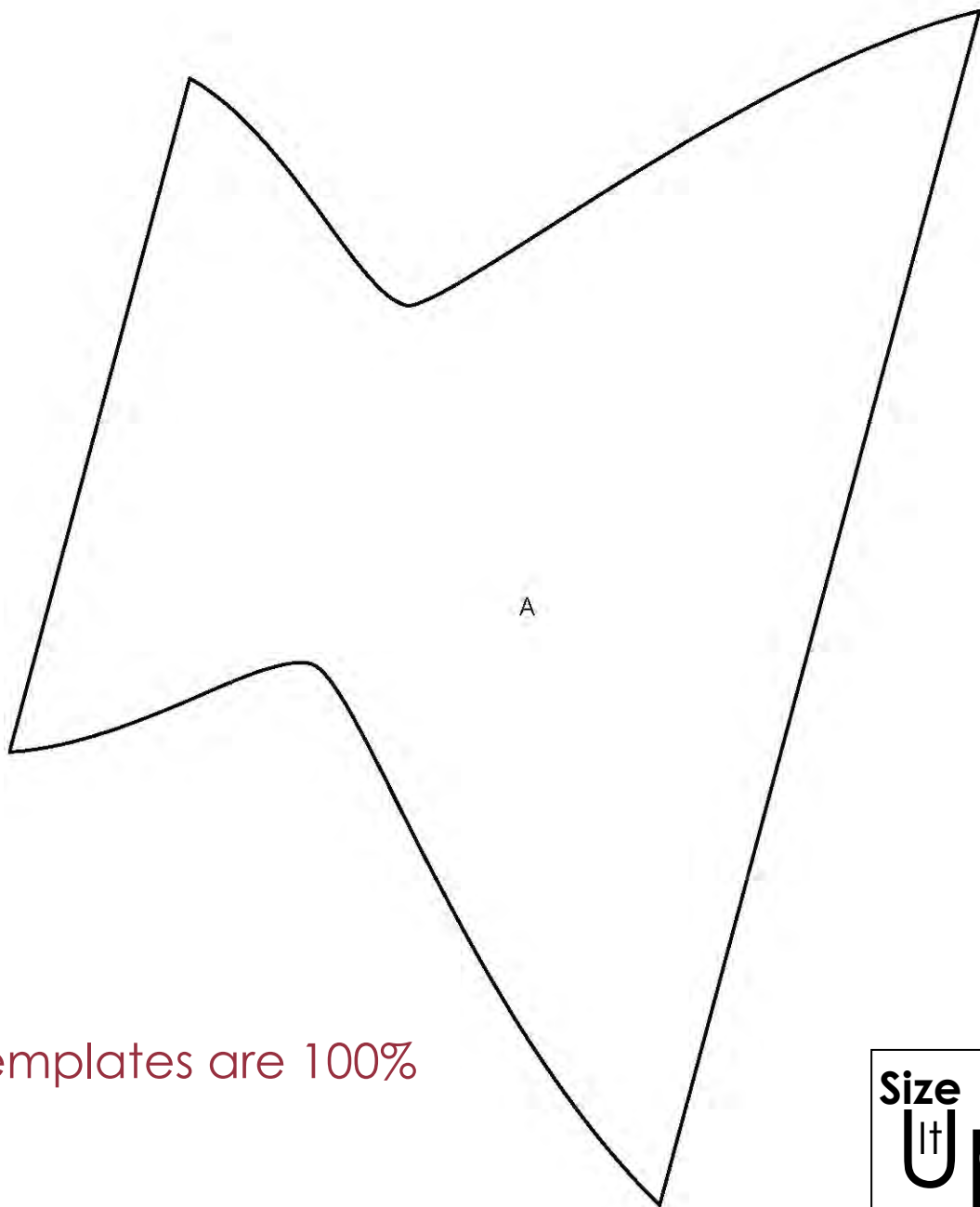

Templates are 100%

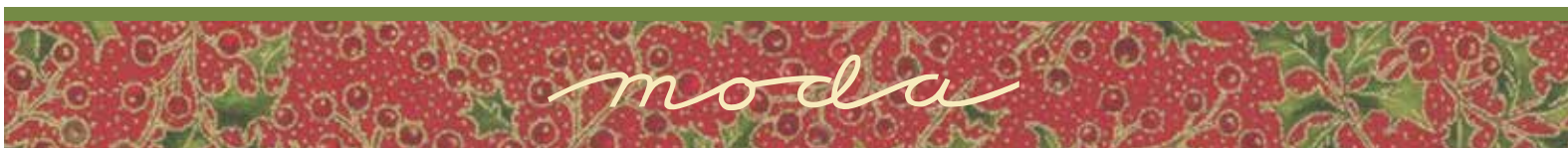
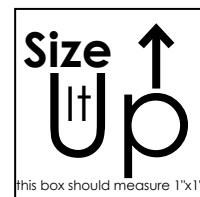

# *Poinsettias & Pine Metallic* Templates

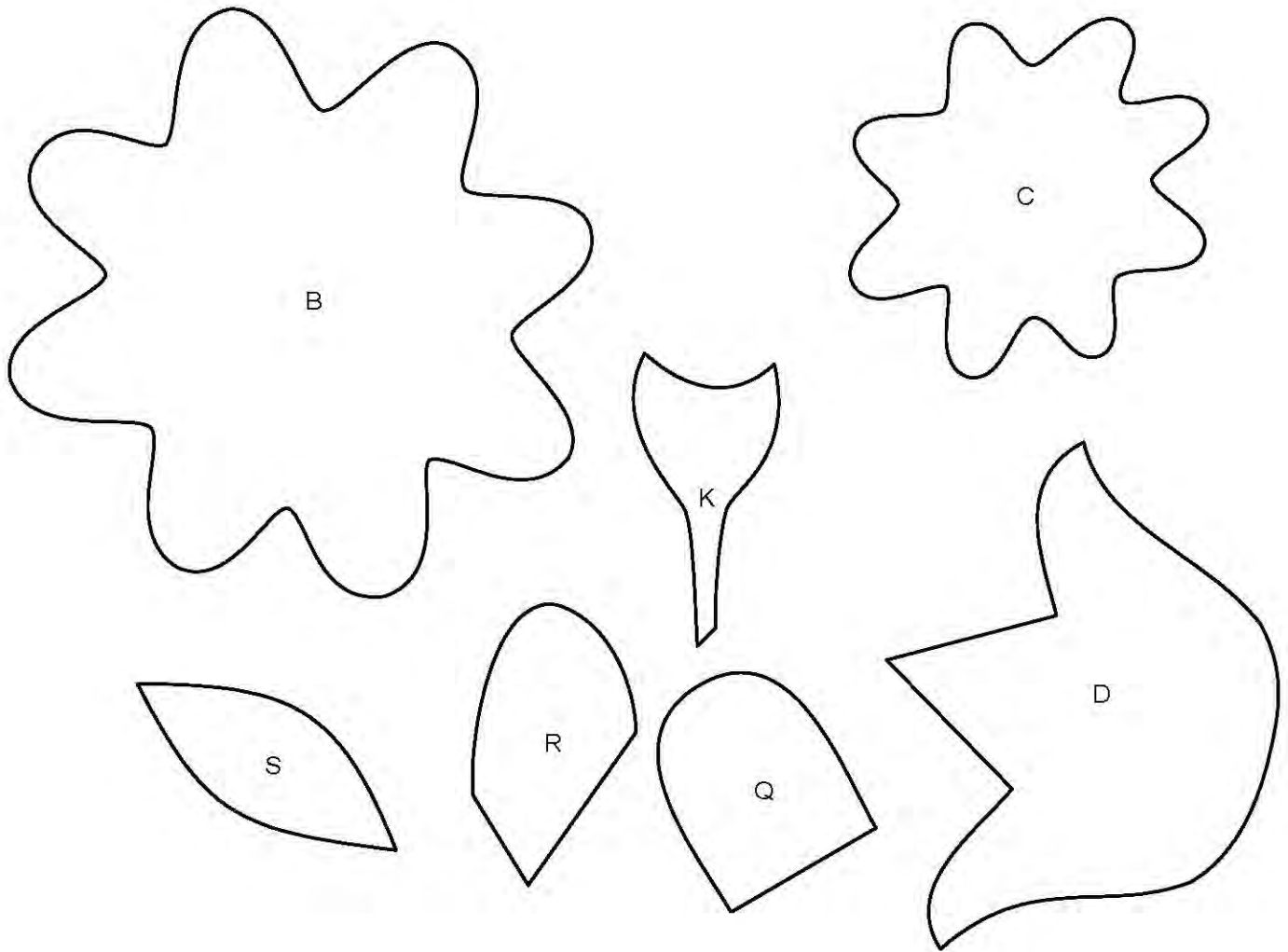

Templates are 100%

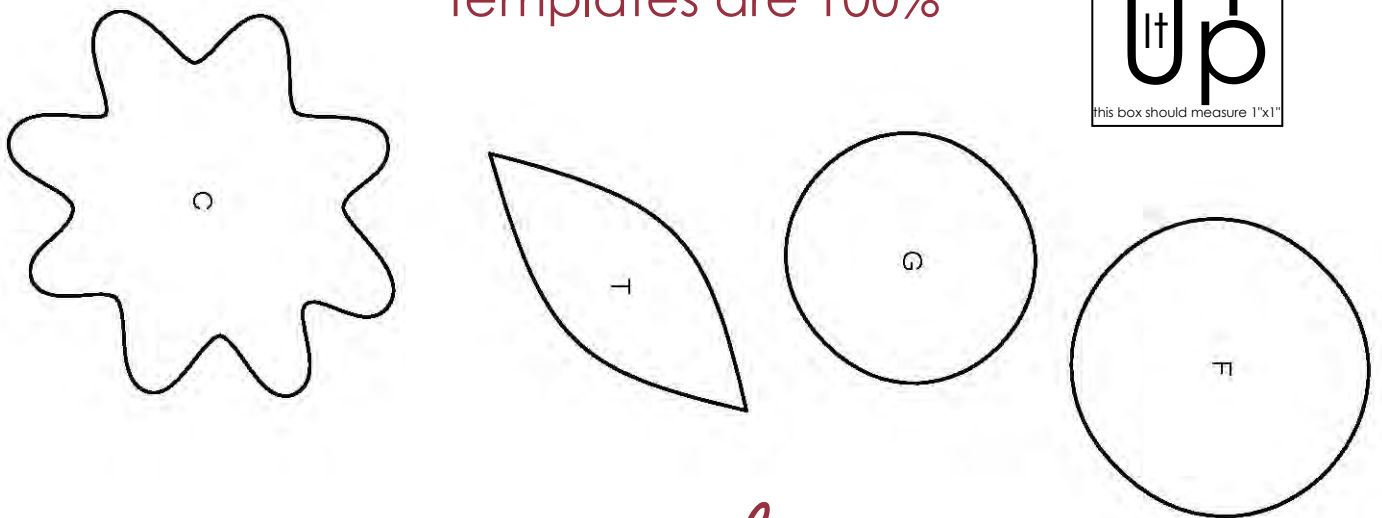
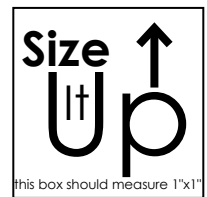

*moda*

# Poinsettias & Pine Metallic Templates

Templates are 100%

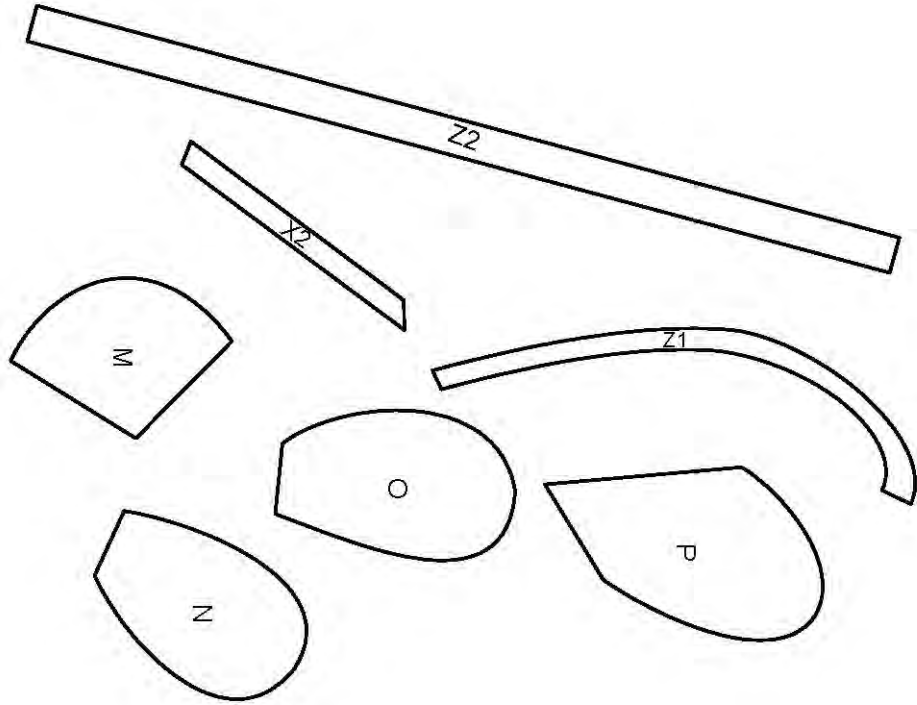

*moda*

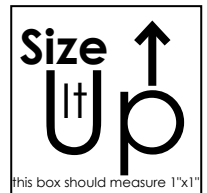
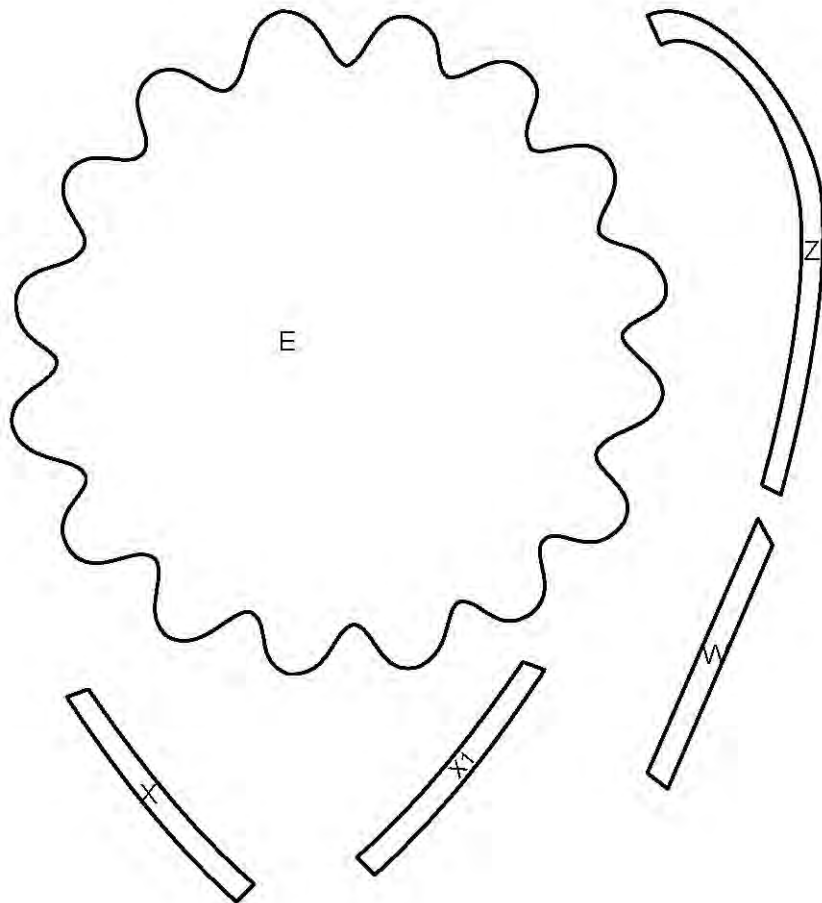





# *Poinsettias & Pine Metallic*

*moda*

Templates are 100%

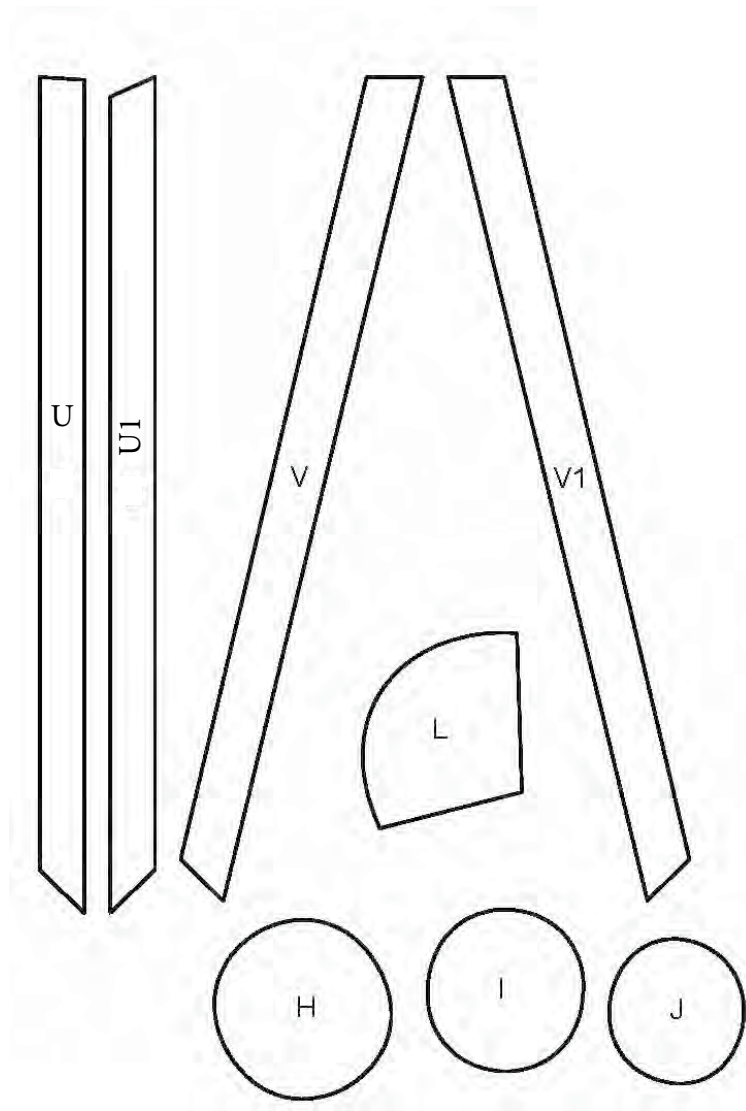

MODAFABRICS.COM  
PS33510 SUGGESTED RETAIL \$10.00